

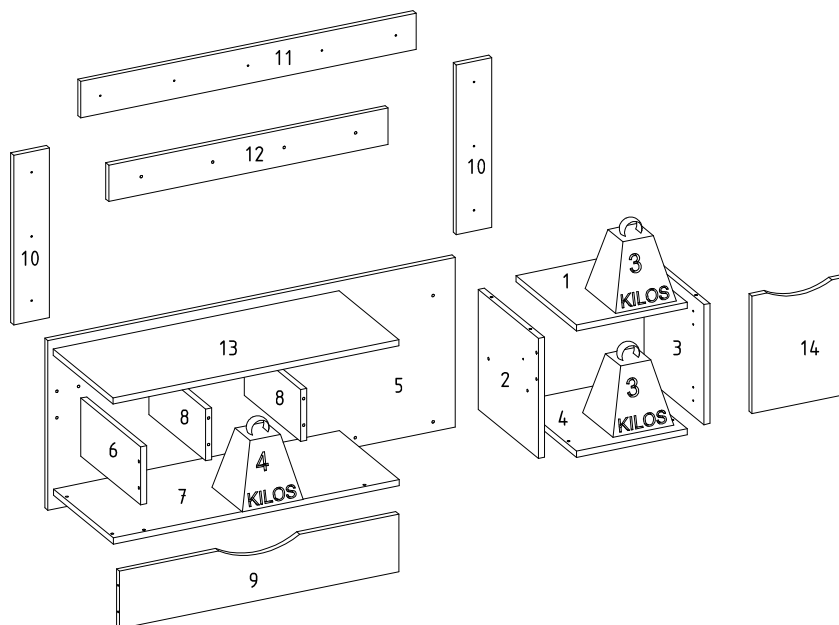

2085 - CAMARIM BLUSH



LISTA DE PEÇAS / Pieces List / Lista de Piezas

SEQ.	REF.	DESCRIÇÃO	DESCRIPTION	DESCRIPCIÓN	MAT. PRIMA	COMP.	LARG.	ESP.	QTD.
1	315775	TAMPO	Top	Arriba	MDP	273	298	15	1
2	315776	DIVISORIA	Divisoria	Divisoria	MDP	290	296	15	1
3	315777	LATERAL DIREITA	Right Lateral	Lateral derecho	MDP	290	296	15	1
4	315778	BASE	Base	Base	MDP	273	298	15	1
5	315779	PAINEL	Panel	Panel	MDP	1005	410	15	1
6	315780	LATERAL ESQUERDA	Left side	Lado izquierdo	MDP	295	140	15	1
7	315781	PRATELEIRA	Shelf	Estante	MDP	705	295	15	1
8	315782	DIVISÓRIA DO NICHU	Niche partition	Partición de nicho	MDP	279	125	15	2
9	315783	VISTA FRONTAL	Front view	Vista frontal	MDP	689	139	15	1
10	315784	TRAVESSA LATERAL	Side Rail	Side Rail	MDP	410	88	15	2
11	315785	MACHO FEMEA COM BORDA	Man femea	Macho femeá	MDP	827	88	15	1
12	315786	MACHO FEMEA SEM BORDA	Man femea	Macho femeá	MDP	689	88	15	1
13	315787	PORTA BASCULANTE	Swing Door	Puerta oscilante	MDP	705	295	15	1
14	315788	PORTA	Door	Puerta	MDP	284	235	15	1

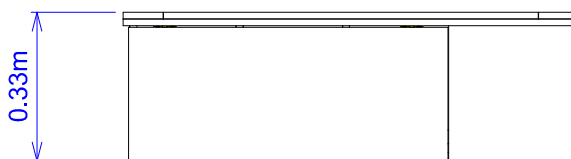
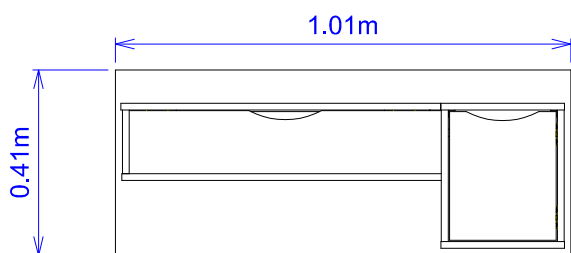

Dimensão do Produto: (L X A X P) - 1.01 x 0.41 x 0.33

INSTRUÇÃO MONTAGEM PRODUTO

Intructions to Assembly / Instrucciones de montaje

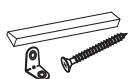

Separate as peças e acessórios de maneira organizada
Separate parts and accessories in way organized
Separe las piezas y accesorios de manera organizada



Forrar o chão com o papelão das embalagens.
Cover the floor with the cardboard
Cubra el suelo con la embalaje de cartón



É necessário 01 pessoa para montar o produto
01 person is required to assemble the product
Se requiere 01 persona para ensamblar el producto.

O produto deve ser a montado por um profissional qualificado
The product must be assembly by a professional
El producto debe ser ensamblado por un profesional calificado

Ferramentas necessárias
(não fornecidas)

Not include tools / No herramientas



CUIDADO PARA CONSERVAÇÃO E LIMPEZA DO MÓVEL

Care to conservation and clean / Cuidados de limpieza

Peso máximo de carga informado refere-se a objetos distribuído de maneira uniforme sobre toda área de contato da peça



The maximum load weight informed refers to objects distributed evenly over the entire contact area of the part
Conjunto de carga máxima de peso se refere a objetos distribuídos uniformemente sobre toda el área de contacto de la pieza de trabajo.



Não molhar o móvel e não expor em lugar úmido
Do not wet the mobile and do not expose in a wet place
No moje el producto y no exponer en un lugar húmedo



Não expor o móvel próximo de fontes de calor.
Do not expose the mobile near heat sources
no esponga cercano de fuentes de calor



Não usar produtos abrasivos.
Do not use abrasive products.
No utilice productos abrasivos.



Limpe com flanela limpa e seca.
Clean with dry cloth
Limpieza con un paño limpio y seco

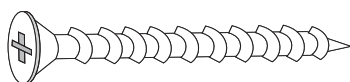

A - 700137-Parafuso 4,5x45 (25x)
screw / tornillo



B- 700124-Parafuso 3,5x25 (11x)
screw / tornillo



C- 700121-Parafuso 3,5x12 (16x)
screw / tornillo

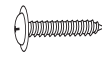

D - 700127-Parafuso 4,0x12 (16x)
screw / tornillo

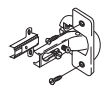

E - 700395 - Dobradiça (04x)
700391 - Calço (04)
hinge / bisagra



F- 700542-Cavilha 6x30 (08x)
peg / cerrojo



G- 700538-Cantoneira (07x)
Corner / esquina



H- 700375 - Espelho (01x)
Mirror / Espejo

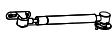

I- 700269-Pistão a gás (01x)
gas piston / pistón de gas



J- 700450 - Bucha parede (04x)
wall bushing /
casquillo de la pared



K - 700139-Parafuso 4,5x60 (04x)
screw / tornillo



L- 700130 - Parafuso 4,0x16 (01x)
Screw / tornillo



M- 700441-Suporte prateleira (01x)
Shelf bracket/suporte de estante



N- 700151 - Parafuso união (04x)
Union screw/Tornillo de unión



O - 700565 - Gota de silicone (03x)
Silicone drop/Gota de silicona



P- 700419-Tapa furo (06x)
hole cover / tapa del agujero

01° PASSO	Fixar peças 2 e 3 nas peças 1 e 4	02° PASSO	Fixar peças 1 e 4 na peça 5
01° STEP	Attach parts 2 and 3 to parts 1 and 4	02° STEP	Attach parts 1 and 4 to part 5
01° PASO	Adjunte las partes 2 y 3 a las partes 1 y 4	02° PASO	Adjunte las partes 1 y 4 a la parte 5
A		A	
C		-	
F		-	
G		-	
-		-	
03° PASSO	Fixar peças 6 e 8 na peça 5	04° PASSO	Fixar peças 7 e 9 nas peças 2 e 6
03° STEP	Attach parts 6 and 8 to part 5	04° STEP	Attach parts 7 and 9 to parts 2 and 6
03° PASO	Adjunte las partes 6 y 8 a la parte 5	04° PASO	Adjunte las partes 7 y 9 a las partes 2 y 6
A		A	
F		C	
-		G	
-		L	
-		M	
05° PASSO	Fixar peça 13 na peça 5 e fixar peça 14 na peça 3	06° PASSO	Fixar peças 10 , 11 na peça 5, encaixar peça 11 sobre a peça 12
05° STEP	Attach part 13 to part 5 and attach part 14 to part 3	06° STEP	Attach parts 10, 11 to part 5, Fit Part 11 on the part 12
05° PASO	Adjunte la parte 13 a la parte 5 y adjunte la parte 14 a la parte 3	06° PASO	Adjunte las partes 10, 11 la parte 5, Ajuste Parte 11 en la parte 12
D		B	<p>Fixar peça 12 na parede Fix part 12 on the wall Fije la parte 12 en la pared</p>
E		J	
-		K	
I		-	
N		-	

